

SmartFil

Art. No.: 64 650 100



Technical Data

Filter	
Filter stages	2
Filter method	Storage Filter
Filter surface	25 m ²
Type of filter	Safe Change Filter
Filter material	Cellulose with polyester nanofibre fleece
Filter efficiency	> 99,5 %
Filter class	E12
Additional filters	Pre-filter (aluminium)
Basic data	
Extraction capacity	1100 m ³ /h
Max. fan performance	3000 m ³ /h
Weight	131 kg
Motor power	1.5 kW
Power supply	3 x 400 V / 50 Hz
Rated current	3.1 A
Control voltage	24 V, DC
Noise level	70 dB(A)
Additional information	
IFA-Certification	W3-Approved
Fan type	Radial fan
Exhaust arm type	flexible exhaust arm
Length of exhaust arm	2 m

Applications

- Suitable for all materials, including high-alloy steel
- Medium levels of smoke and dust
- Frequent use
- Alternating work places

Benefits

- Exhaust arm requires less adjustment due to flow-optimised exhaust hood design
- Increased safety due to filter monitoring
- Increased safety with safe filter change
- Very economic due to long lasting high capacity filters

Properties

- 360 degrees rotating exhaust hood with damper
- 25m² filter surface
- Compact and solid design
- W3/IFA certified
- Exhaust arm 2 m

Accessories

- Automatic start-stop
- Workplace lighting incl. on/off switch at the hood



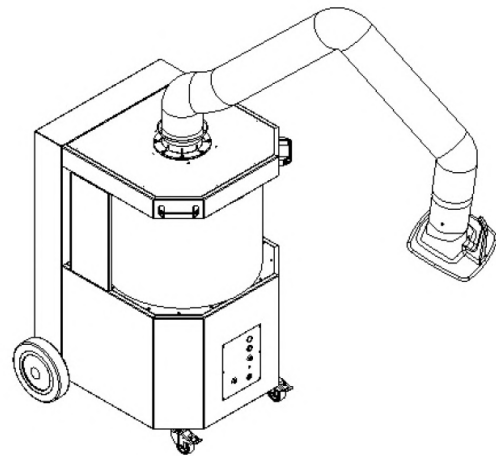
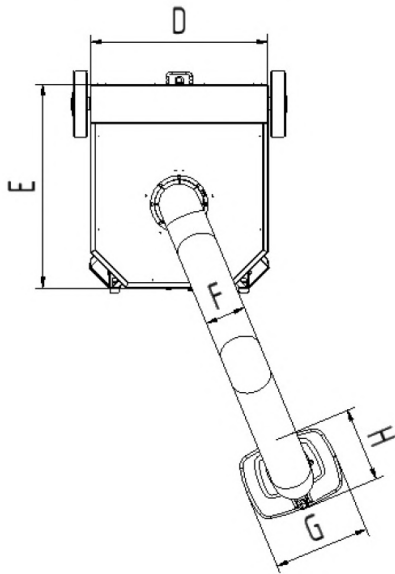
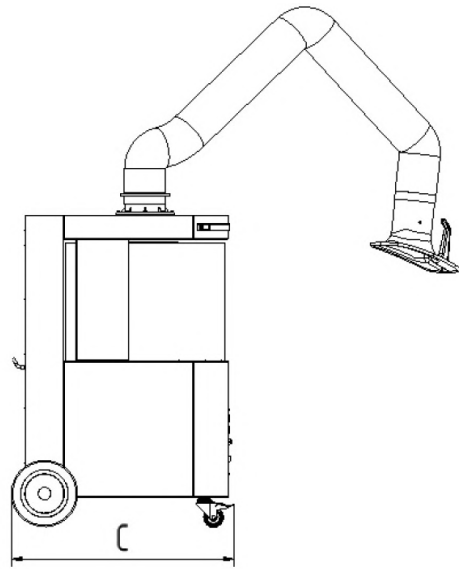
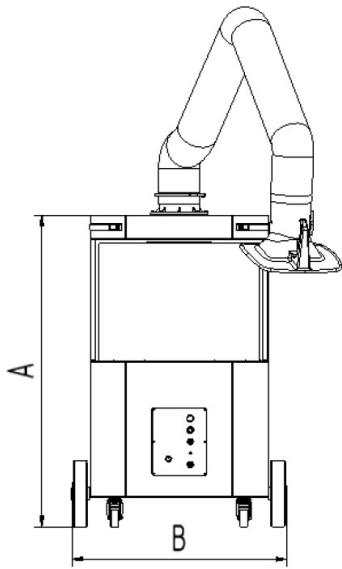

Technical Data

Dimensions

A	1169 mm
B	795 mm
C	836 mm
D	667 mm
E	764 mm
F	150 mm
G	360 mm
H	295 mm